

## External Fitting Instructions

Thank you for purchasing an RV Roof Airlifter System. Please read through the instructions before you start the installation. Check you have received and identified all the parts and are familiar with their proposed location. Ensure you have the tools and skills to fit the system. Preparation and rechecking your work is the key to a successful installation.

### WARNING

**DO NOT REMOVE OR ALTER THE MANUFACTURERS LIFTING SYSTEM WHEN FITTING THE AIRLIFTERS. THE AIRLIFTERS ARE DESIGNED TO LIFT THE ROOF IN CONJUNCTION WITH THE EXISTING LIFTING MECHANICAL SYSTEM. YOUR RV ROOF MUST BE CAPABLE OF BEING LIFTED MANUALLY AND HELD IN PLACE BY THE MANUFACTURERS LIFTING MECHANISM WITHOUT THE AID OF THE AIRLIFTERS. IF YOU REMOVE OR ALTER THE MANUFACTURERS LIFTING MECHANISM YOU MAY CAUSE INJURY TO YOURSELF AND OR OTHER PEOPLE DUE TO THE RAPID DESCENT OF THE ROOF. AS SUCH RV ROOF AIRLIFTER SYSTEMS ACCEPTS NO RESPONSIBILITY WHATSOEVER.**

### Kit contains:

|   |  |                            |
|---|--|----------------------------|
| 4 x Custom made airlifters with brackets    | 1 x 6mm T' fitting                     | 1 x tube sealant           |
| 20M Black 6mm airline                       | 1 x Nitto compressor fitting           | 2 x Battery connections    |
| 1 x Regulator & mounting bracket            | 1 x 85lpm compressor & air hose        | RV Sticker                 |
| 1 x Bulkhead fitting with two washers       | 5 x 'P' black plastic clips and screws | 1 x Fitting instructions   |
| 6 x 6mm corner fittings                     | 45 x self-tapping screws               | 1 x operating instructions |
| 1 x 6mm 'Y' fitting                         | 1 x 14mm spade bit                     |                            |
| 1 x Control relief valve & mounting bracket | 4 Velcro pieces                        |                            |

### Parts photos:

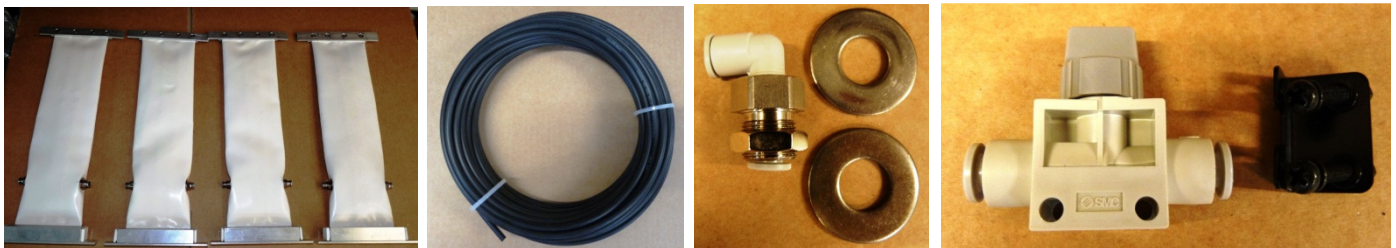

|                    |                     |                   |                                   |
|--------------------|---------------------|-------------------|-----------------------------------|
| 4 x Airlifters     | 20M Airline         | Bulk head fitting | Control exhaust valve & Bracket   |
| Compressor fitting | Regulator & Bracket | 'T' Piece         | 6 x Corner fittings & 'Y' Fitting |

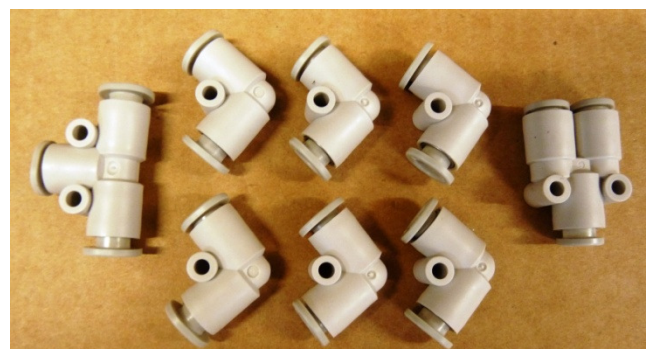
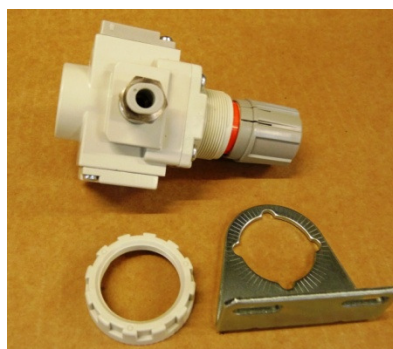

**Tools Required:**

|                                       |   |                     |
|---------------------------------------|---|---------------------|
| Cordless or electric reversible drill | Phillips head screwdriver tool (magnetized) | Tape measure        |
| Cartridge gun for sealant             | Pencil / marker pen                         | Stanley style knife |
| Step ladder                           | Sand paper                                  | Cloth / rag         |

**YOUR SAFETY IS IMPORTANT**

It is important that you have the skills and tools to successfully carry out the installation. A list of installers is available on our website.

**Before you start:**

Select an open level area to work in with room for the roof to be fully elevated with no overhead obstructions and or dangers, i.e. power lines, beams, roof trusses or the like. Keep all power tools away from water / rain. An earth leakage unit is recommended when using 240v power equipment. Take care when working at heights.

Take the time to check and follow the various stages outlined before you start the actual install, to ensure a successful installation.

1. Location for airlifters
2. Location of 'Y' fitting
3. Location of Bulk head fitting if required
4. Location of air supply line
5. Location of compressor
6. Location of regulator
7. Location of control exhaust valve
8. Location of separate on/off switch where applicable (not supplied)

**Location of airlifters:**

As part of the ordering process you should have predetermined where you will be positioning the airlifters. The airlifters can be fitted at the end or the sides of your RV. It preferable to locate them on the sides fore and aft of the gas struts or scissor lifts depending on your RV. Place towards the end of the RV no closer than 300mm from the corner. Keep them clear of windows and adjacent to but not directly over the canvas bows / skirt stiffeners which fold the skirt back in. On large RV's i.e. Coromal 615 the airlifters can go inside the gas struts.

**Note 1:** Check inside that there is sufficient room when the roof is lowered, for the airlifter to fit and that it won't rub on the skirt or be jammed between the ceiling and internal furniture.

**Note 2:** Check the length of the airlifter is correct as are the bracket styles. The airlifters should be 15mm longer than the skirt height.

Once satisfied you have selected the right location for the airlifters mark the position for the top and bottom brackets. Do this for all the airlifters.

The airlifters can be fitted at the Side (A) or the Rear (B) of your RV. See plan at end of instructions. Ideally they will be clear of any window openings, adjacent to a skirt folding/stiffener and be clear of the cross arms or gas struts. Do not put in between the gas struts as they will be too close to the centre of the RV unless it is a long roof i.e. 6M.

(Preferably no closer than 300mm to the corner as the skirt has to fold in)

*Note: Then check inside whilst the roof is in the lowered position for any internal furniture that may limit the available space for the airbags and fittings. Relocate airlifters if necessary.*

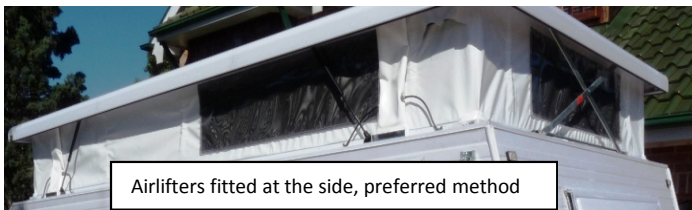

**Choosing Location of Y fitting. - Bulk head fitting or alternatively the use of J Mould**

The Y fitting must be fitted between the front and rear airlifters. Not between the front airlifters or between the rear airlifters, why? The air will enter / leave the airlifters evenly when the 'Y' fitting is between the two sets or front and rear airlifters. If the 'Y' fitting is between a set of airlifters all the air from the opposite end must then filter through the 1st set of lifters. This 'Y' fitting can be on either side of the RV but generally on the near side near the door.



External View showing  
**'Y' fitting**  
and  
**'bulkhead fitting'**



Use of J Mould if applicable saves the need for using the bulk head fitting by running the airline under the rubber weather strip.



**Location of Bulk head fitting**

The bulk head fitting can be located anywhere around the top rim of your RV but close to the 'Y' fitting so that the internal airline is hidden from sight as much as possible. You also need to consider where you will be locating the compressor, running the airline and where you will be accessing power from at this point in time. (Do not rush this

part.) Quite often this can be concealed within a wardrobe / cupboard and run to the required location under lower cupboards.

*Note1: You must be able to fit the washers top and bottom and the lock nut on the bottom of the bulkhead union. Also ensure you can get your hand and a spanner in the area **before** you drill the pilot hole. Mark the centre of the proposed hole and recheck externally and internally for alignment and clearance.*

*Note2. Check for any internal wiring especially in mobile homes and campervans as they often run 240v and 12v in roof voids.*

### **Using the external corner 'J' mould in lieu of the Bulk Head Fitting**

Some RV's have a corner mould often referred to as the 'J' mould, which runs around the external corner / roof line of the RV with a soft cover strip in it. To save drilling through the roof of your RV you can make a small incision in the rubber and run the airline within the moulding below the cover strip to the bottom of your RV and then come bring the airline in underneath the RV into a locker / compartment.

### **Location of Compressor**

When placing your compressor in compartments look for ease of access for the actual operation of the compressor. You will find this beneficial when you want to lift the roof and access to the Control/exhaust valve. External access is better especially if you want to use it for other applications, i.e. using it to pump up tyres etc. if you locate the compressor in a cupboard or under the bed you will need to incorporate a separate on / off switch.

Also at this point consider how you will run the airline to the compressor from the airlifters (see above)

**DIRECT access is required to the 12v BATTERY power supply.** Ensure adequate ventilation as the compressor will run hot when in use for a period of time, i.e. pumping up tyres.

**Do not use a low or light supply feed like a 12v cigarette lighter socket (30amp draw) from compressor.**

### **Location of separate on/off switch ( switch not supplied)**

If the compressor, 12v switch (30amp) and control exhaust valve need to be fitted internally to suit your needs then again find a suitable location in a panel where they will not be in the way of egress and use of the RV. Most panels are 3mm ply and you will need mounting points for the brackets.

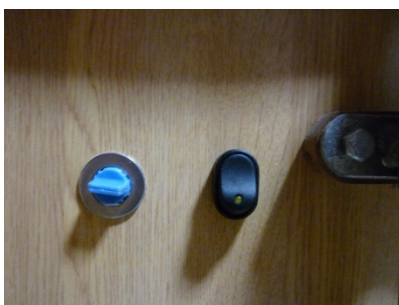

Different fitting styles in various locations internally in the RV's.

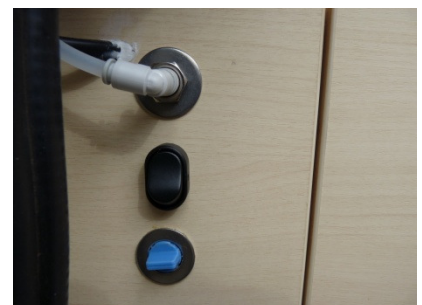

### Fitting of the various components.

Now you have worked out where things are going to go it is time to start the actual fit out.

### Fitting the airlifters

Check that the airlifter brackets you ordered will fit to the profile framework top and bottom and are the correct length.

*Note: The airlifters should be approx 15mm longer as when they are inflated the overall length decreases.*

Using a pencil and mark the selected location of the brackets both top and bottom ensuring the airlifter is vertical, do the same for each airlifter around your RV. You can either tape in place temporarily or fit using the screws provided (see fitting airlifter section below). Once all airlifters are secured temporarily **check that the roof closes and the airlifters / fittings are not pressed against the skirt.** You need to push the airlifters in against the skirt, (another pair of hands is useful here) you need as minimum a few millimetres of free space.

### Fitting the airlifters

Having done the hard part in establishing the location for all the parts you can now start to fit the airlifters. Centre punch approx 20mm in from each end on the top of the bracket (Type 1 & 3 brackets) it will be behind the airlifter on the (type 2) angle brackets. You may find it easier to pre drill with a pilot hole first. Using a drill fitted with a suitable drive fasten the brackets in the pre-marked areas using the self tapping screws. The airline fittings are to be located at the bottom of the airlifters. Fasten the left hand side of the bracket first as they can twist when screwing into place. you could damage the skirt and or your hands.

*Note 1: Take care not to strip the thread as you tighten the screws and it may be necessary to reverse the screw then retighten to get a snug fit. Clear out any aluminium filings from under the bracket.*

*Note 2: If you fasten the top bracket first, fold the airlifter back over its self so it rests on the roof whilst you screw the bracket in place. This gives you clear vision and the airlifter will hang vertically when folded back down to fasten the bottom bracket.*

To fit the Velcro to the pop top skirt ensure the area is clean from dirt or grease, you may use sugar soap or prepsil to clean the area. Then mark the areas opposite the existing Velcro on the airlifters (at each corner) making sure the airlifter is central. Remove the bottom mounting screws on the airlifter. Clear out any debris from the drilling. **Lightly** sand the area you are going to fasten the Velcro to on the skirt. Check the position for the Velcro is correct as once applied with the sealant and dry it can't be relocated. (Use the 50mm wide Velcro provided and fasten it to the pop top skirt by using the sealer/adhesive supplied. Run a bead of sealer around the outside on the back of the Velcro and down the centre. Then position in place, pressing the sealer flat out to the edges. Wipe clean (mineral turps) and allow to dry, Minimum of 2hrs up to 24hrs depending on weather conditions.)

Keep the two sections of Velcro apart until dry. Allow the sealer under the Velcro to adhere properly. when you join the two Velcro sections together start from the bottom pulling the airlifter up tight. So any excess is above the Velcro.

Refasten the bottom bracket applying sealant over the drilled hole before you align and screw into place. Fasten all airlifters into place.

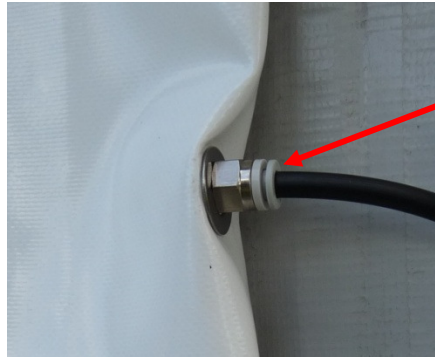

Hold fitting in one hand and push grey collar in to main part of fitting using thumb and forefinger. Then gently ease the airline out while the fitting is compressed.

### Connecting the airline

When cutting the airline use a sharp Stanley type knife cutting it squarely at 90 degrees to the airline. Ensure you push the airline in fully as they are a tight fit. Moisten the end of the airline if required or wipe a small amount of silicon spray / grease over the end. Use the natural bend in the airline to assist in aligning the bend and angle into the airlifter. This will help with the airlifter when it folds in. If the airline is pointing outwards it will tend to kick the airlifter outwards at the fitting. Should you need to remove the airline from a fitting DO NOT just pull it out. It is done by sliding the collar of the fitting towards the airlifter and fitting with your thumb & forefinger which releases a collet inside. Then using use other fingers ease the airline gently backwards allowing the airline to be removed.

Start fixing the airline in place from one airlifter and work around the RV clipping in place as you go. Use the corner fittings at each corner of the RV. Do not screw these down or you may well end up drilling into the RV interior. Use 'P' clips provided to fasten the airline in place. seal as you



|                                     |                                 |                          |
|-------------------------------------|---------------------------------|--------------------------|
| Drill hole using self tapping screw | Remove filings and apply sealer | Re-screw clip into place |
|-------------------------------------|---------------------------------|--------------------------|

**It is important to seal all penetrations to prevent any moisture entering the RV framework.**

Note: Use the sealer and any cleaners as described by the manufacturer for recommended safe usage.

Start on the long side first so if you cut it too short you can use it on the shorter side. Work your way around the RV allow sufficient airline to form a loop when entering and leaving the airlifter.

# RV AIRLIFTERS

Simplifying R.V. and Camper travels worldwide



If the airline is too short it will pull down when inflated. See the picture on right.

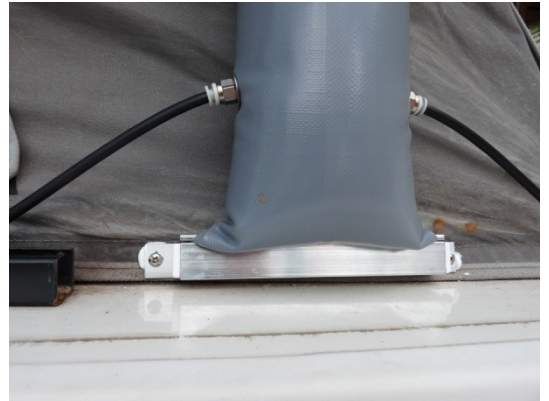

You want to connect all the airlifters to a common airline around the RV. The 'Y' fitting will be inserted afterwards.

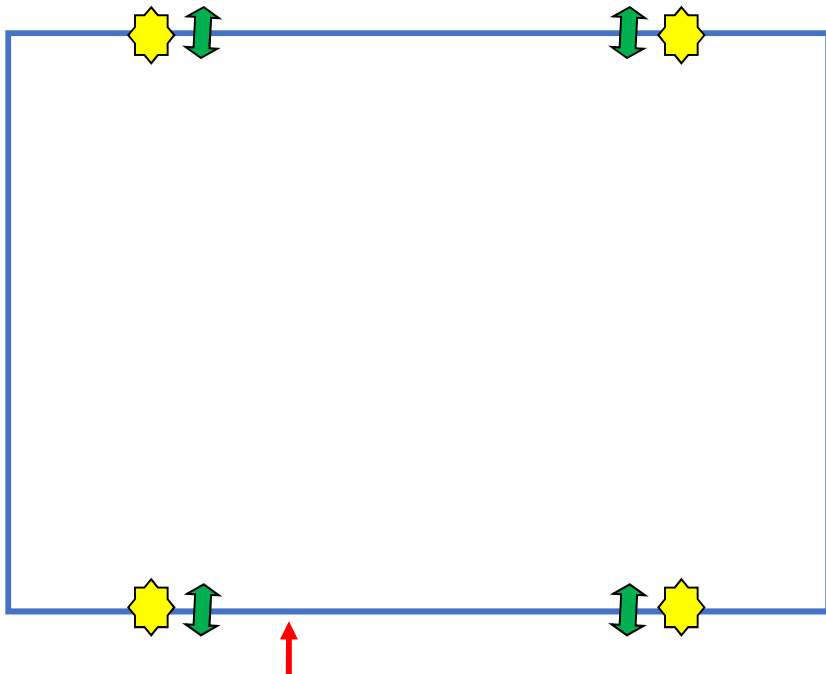

|            |  |
|------------|--|
| Airlifters |  |
| Airline    |  |
| Gas struts |  |

Fit the 'Y' fitting between the front and rear airlifters it doesn't have to be central.



|                                |                                    |                                 |
|--------------------------------|------------------------------------|---------------------------------|
| Clip airline neatly into place | Use corner fittings at each corner | 'Y' fitting & bulk head fitting |
|--------------------------------|------------------------------------|---------------------------------|

## **Fitting the bulkhead union when you can't use the J mould**

Having successfully fitted the airlifters you next need to place a washer from the bulkhead union onto the top of the poptop framework where you have selected to enter the RV. Mark the centre of the hole of the washer. It is very important to get this spot on.

*Note: By measuring the distance from your pencil mark back to the poptop skirt on the outside you can then recheck the internal measurement before drilling any hole, thus ensuring you have room for the fitting / washers both internally and externally.*

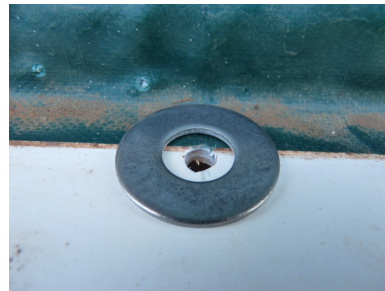

Once satisfied drill a 1/8" pilot hole and recheck using the washers as a guide and that the washer can be located with the pilot hole being central both internally and externally. Adjust if required. Again once satisfied, drill a 14mm hole using the spade bit (supplied), taking care not to damage any internal fittings as you cut through. Remove any excess aluminium filings and insert the fitting and check for clearance.

Now using the sealer provided place sufficient on one of the washers and place over the hole on the outside of the RV, run a small bead of sealer just under the nut on the fitting then insert the bulkhead union ensuring you don't get sealer into the airline fitting. Next apply sufficient sealer to the 2<sup>nd</sup> washer to seal from inside and slide over the threaded shaft and fit the nut to hold it all in place. Using two spanners tighten the bulkhead union ensuring the outlet is parallel to the RV roof line. A second pair of hands is useful at this time if you can't lock the external spanner in place. Clean up excess sealer and test for water tightness taking care not to put any water into the bulk head union as it will go straight into your RV.



If locating bulk head fitting in a cupboard drill a larger hole to accommodate the washer and nut before drilling the 14mm hole from the outside, using the pilot hole as a guide.



## **Fitting the internal airline and compressor**

Next continue the airline to the compressor location in your RV from the bulk head fitting. *Note: If drilling through cupboard walls it is recommended that you use a small pilot hole first and drill from both sides with a larger bit for the airline. This will reduce the possibility of splintering any timber ply / veneer . Check for wiring etc before drilling.*



# R.V. AIRLIFTERS

Simplifying R.V. and Camper travels worldwide

Remember to allow sufficient space for the regulator, control relief valve and compressor fitting where you are locating the compressor. The order of the fittings need to be - compressor connection, regulator and then control relief valve, check the directional flow arrow on both the regulator and control relief valve. Incorrect fitting will prevent the air from being released from the control relief valve and the regulator from working properly

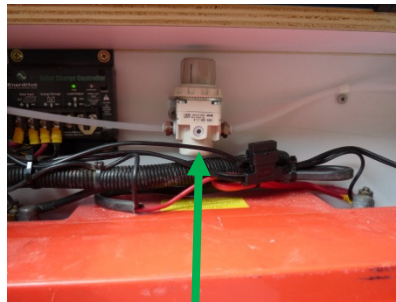
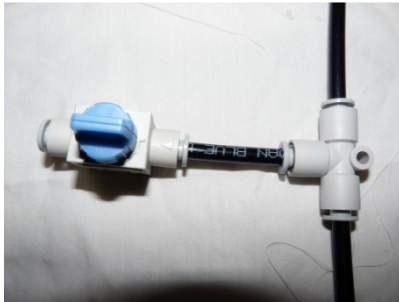

|  |  |  |
|--|--|--|
| Insert 'T' after the regulator in the supply line to the airlifters. | Install regulator between the 'T' fitting and compressor | Locate compressor in locker for easy access and good ventilation |
|--|--|--|

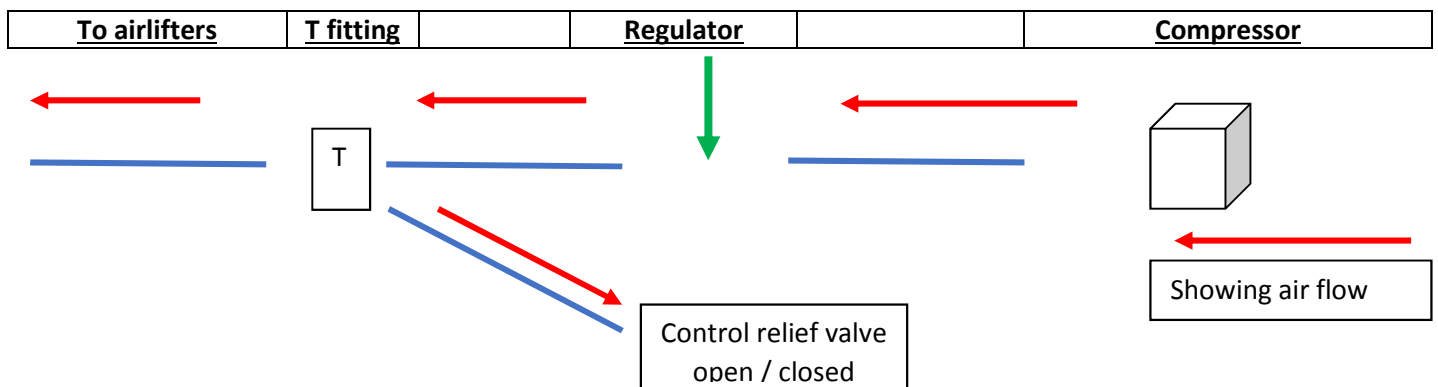

Attach the control relief valve at the end of the 'T' Piece using the bracket provided. Use sufficient airline to suit the required position of the control relief valve. when the control knob is in line with the airline it is open and releases air from the system. when turned at 90 degrees it closes the control valve allowing air to flow to the airlifters. See operating instructions.

**You must ensure the compressor has adequate ventilation to prevent overheating during normal operation as the unit will generate heat. Excessive heat can damage the compressor and void the warranty.**

You can choose to leave the compressor free standing, or screw it to the floor of the RV or fit a small elastic clip / Velcro ( not provided) for easy clip down / removal. A bracket is provided to mount the regulator. The regulator and control relief valve must be located correctly for air flow, check the base for the directional arrow indicating the airflow.

### THE REGULATOR NEEDS TO BE SET

This can be done by pulling the cap up, exposing a red band below. Turn the compressor on and by rotating the cap clockwise it will gradually increase the air pressure setting, continue to adjust the regulator till the air pressure is just sufficient to fill the airlifters and raise the roof. Then turn the compressor off. Push the cap down and the regulator will be limiting the excess air at this point.

You may choose to hard wire your compressor into the 12v power supply. This can be done by cutting of the existing battery clips off and fit directly to your power supply using the battery connectors provided.

*Note: Take care to ensure you do not cross the wiring at this point, do one at a time or you may damage the fuse and or compressor. N.b. This is not covered under the warranty.*

When you have completed fitting the system check to ensure it is working properly. You may need to adjust the regulator if you haven't already done so. When pulling the roof down after you have raised it allow approx 15mins to enable the air pressure to escape and that you have the control relief open. Check the airlifters are folding in correctly and not squashing down. The airlifters are reliant on your canvas bows working correctly as they fold the skirt in also. Do not try to pull the roof down when the airlifters are inflated as you may damage your roof lining.

### **Important message**

Do not stand under the poptop roof whilst it is being raised incase of a failure in the airlifter system i.e. power loss to the compressor, as the roof could close quickly if the gas struts and or cross arms have not extended fully.

**If you use the compressor for inflating tyres ensure it is well ventilated to prevent overheating.**

### **Fault finding - Please read before ringing up.**

If the roof fails to lift or only partially rises check the regulator setting as it may need further adjustment. You can cross check if this is the problem by bypassing the regulator and doing a test without it in the airline.

If the roof still doesn't elevate check all the fittings that the airline is cut & inserted correctly and you haven't kinked the airline. Ensure you have cut the airline squarely at the ends, not at an angle or it will leak. Push airline in securely, you will feel it as it pushes home.

Check for leaks by listening at each fitting when the system is under pressure. You will find the airlifters will lose air naturally over time as the material is slightly porous. They are not designed to hold your roof up continuously.

Check that both the regulator and relief valve are correctly positioned with the directional arrows that are on the base of the units, are pointing in the same direction as the air flow from the compressor.

If the relief valve is inserted the wrong way it will not regulate the air pressure and you may damage the airlifters due to excessive pressure.

**Please contact us for any assistance during the installation or should you encounter any problems later.**

Caution: When lowering the roof ensure the relief valve is in the open position for at least 15 minutes and the airlifters are soft to touch. Some air will remain which helps cushion the roof, this is normal.

**DO NOT** apply excessive force by pulling down against full or nearly full airlifters as you may damage your roof lining and or lowering system.